

4

3

2

1

B

B

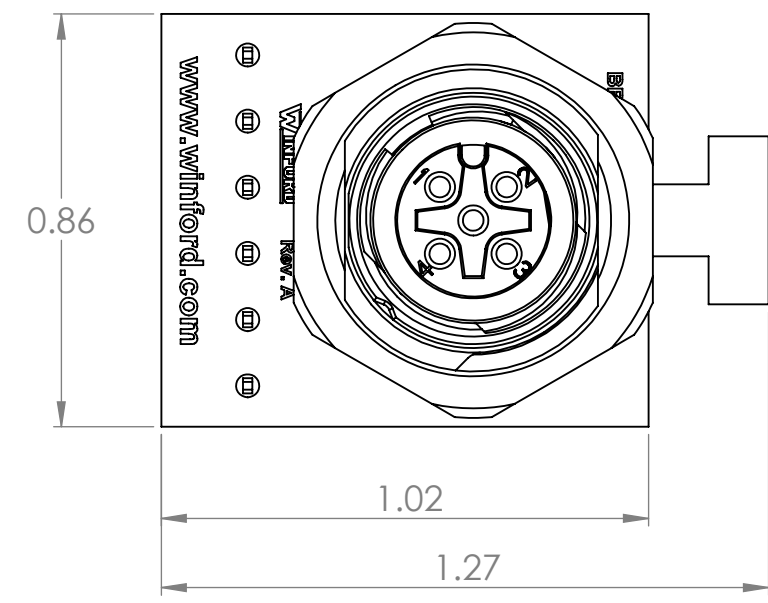
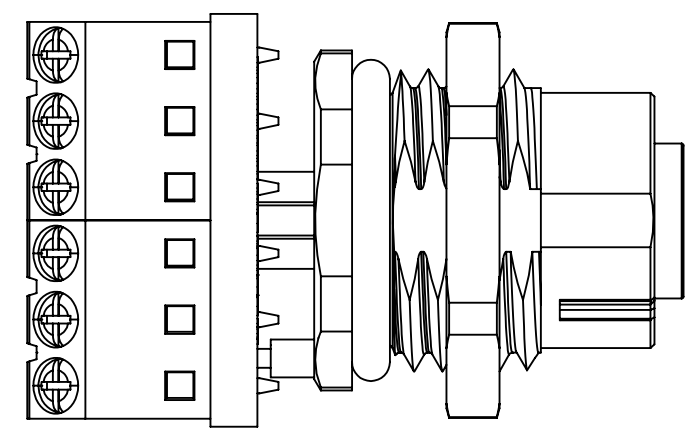
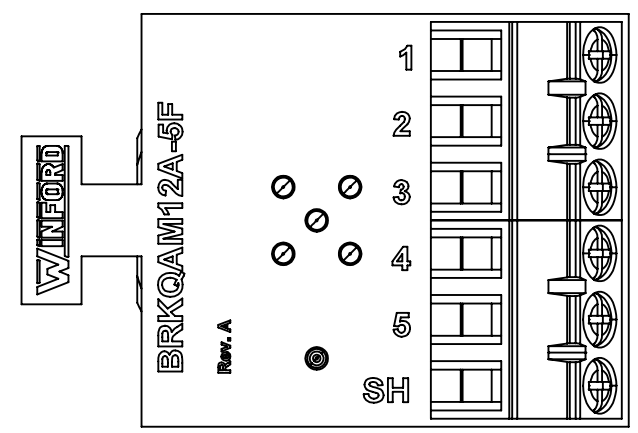

A

A

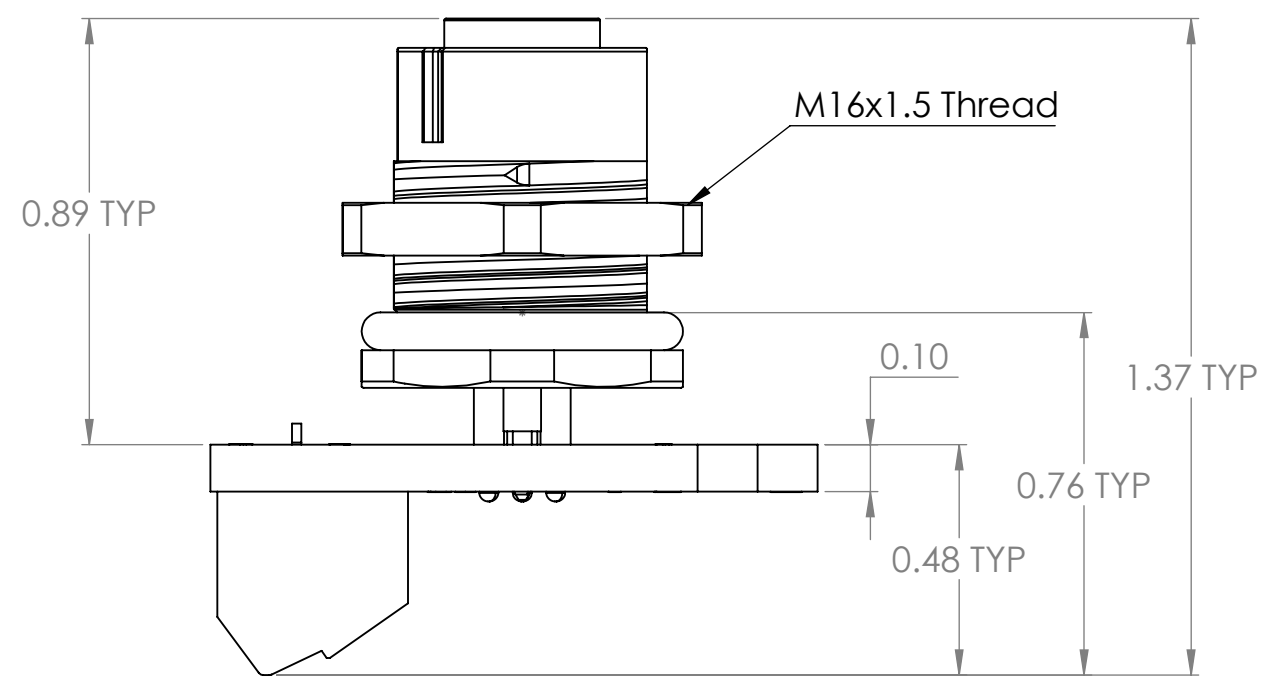
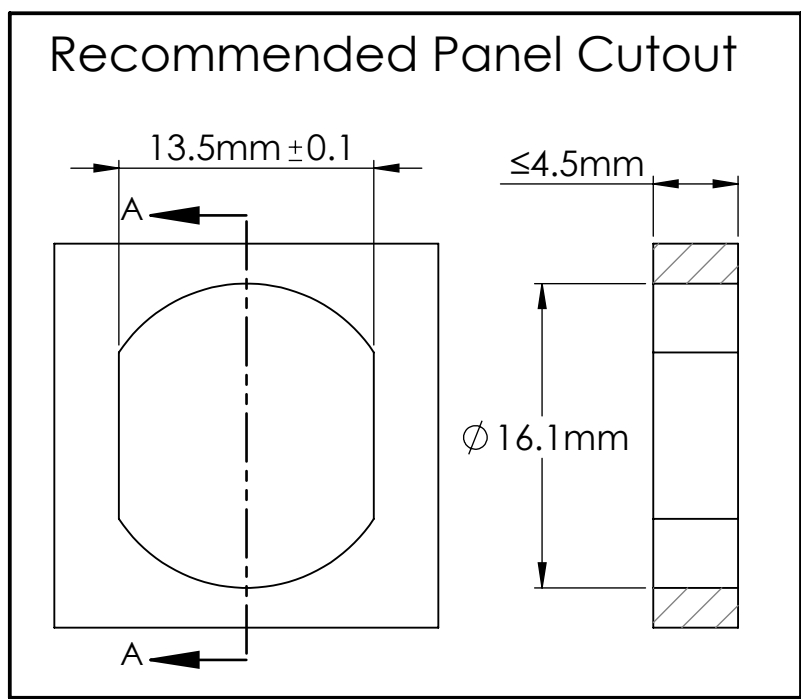
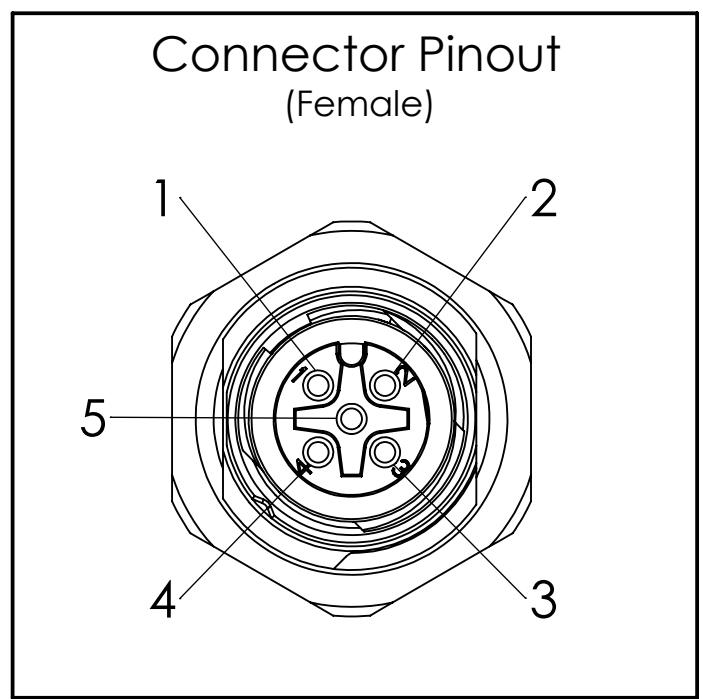

DIM: INCH	DATE: 02/16/2024	RoHS COMPLIANT: Yes	DESCRIPTION:
			M12 5 Pin Female Breakout Board
WINFORD ENGINEERING, LLC 4561 GARFIELD ROAD AUBURN, MI 48611			PART NUMBER (S)
www.winford.com			BRKQAM12A-5F-A
989-671-9721			PART REVISION
			A

4

3

2

1