

4

3

2

1

B

B

A

A

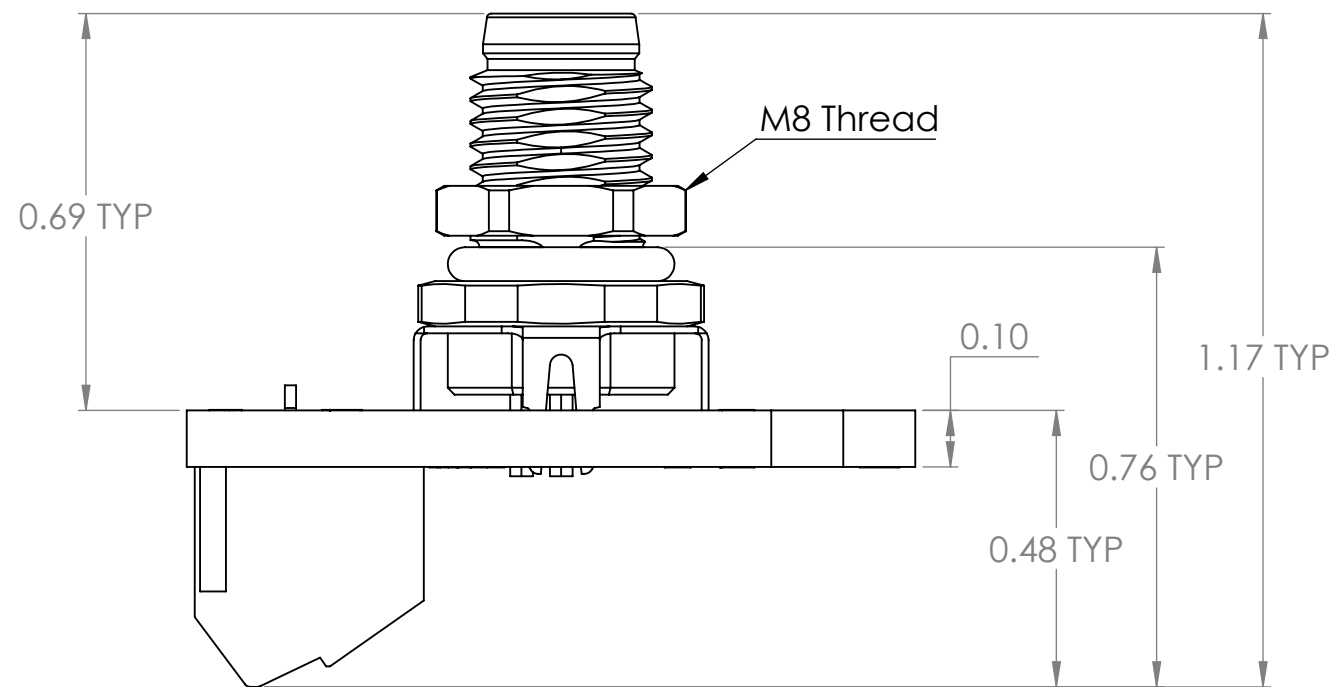
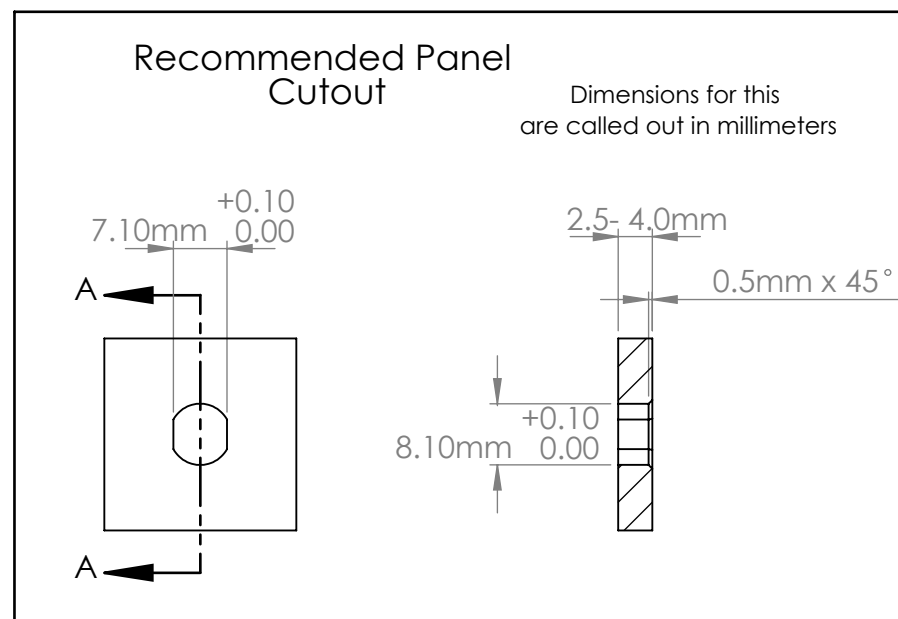
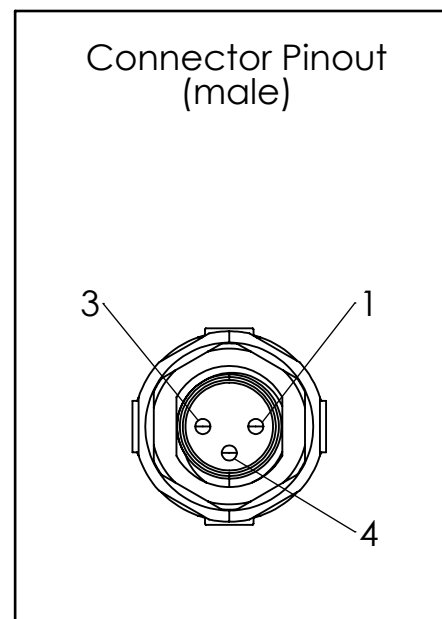
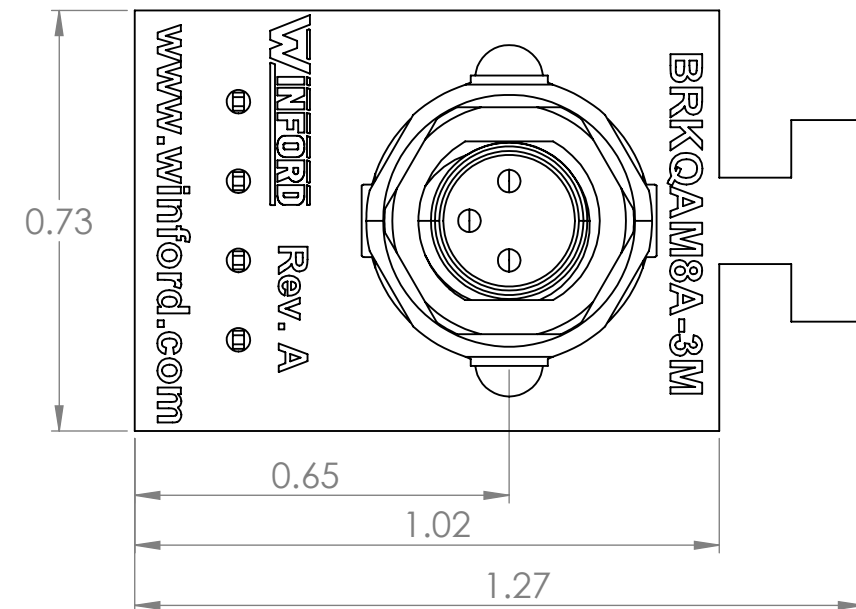
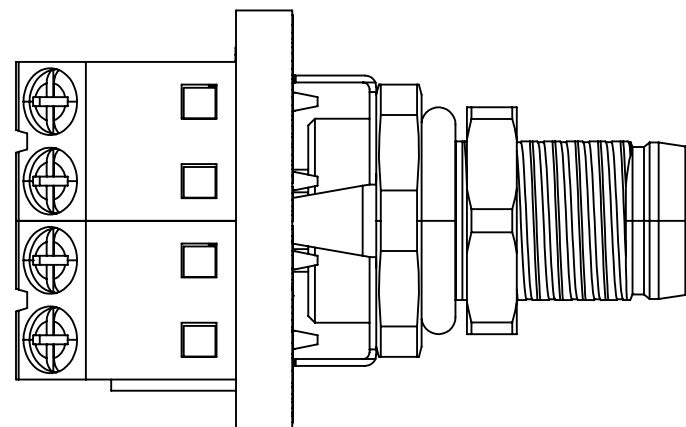
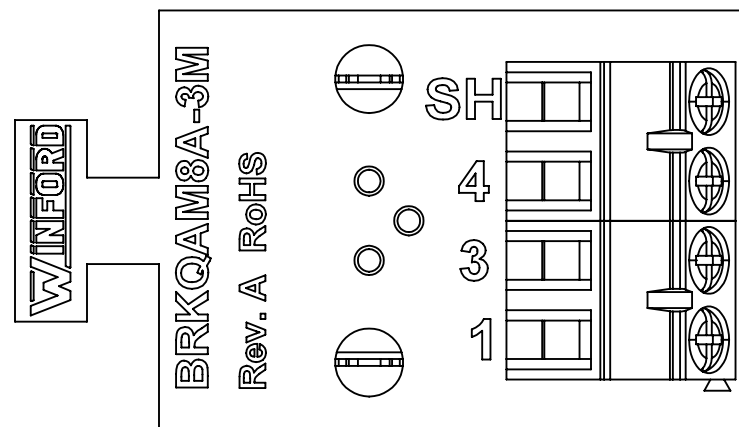

DIM: INCH	DATE: 04/15/2021	RoHS COMPLIANT: Yes	DESCRIPTION:
			M8 3 Pin Male Breakout Board
WINFORD ENGINEERING, LLC 4561 GARFIELD ROAD AUBURN, MI 48611			PART NUMBER (S)
www.winford.com			BRKQAM8A-3M-A
989-671-9721			PART REVISION
			A

4

3

2

1