

4

3

2

1

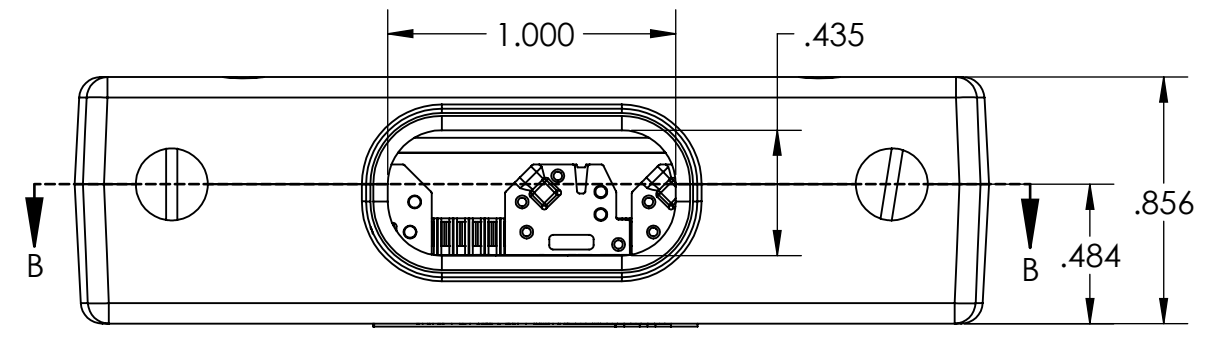
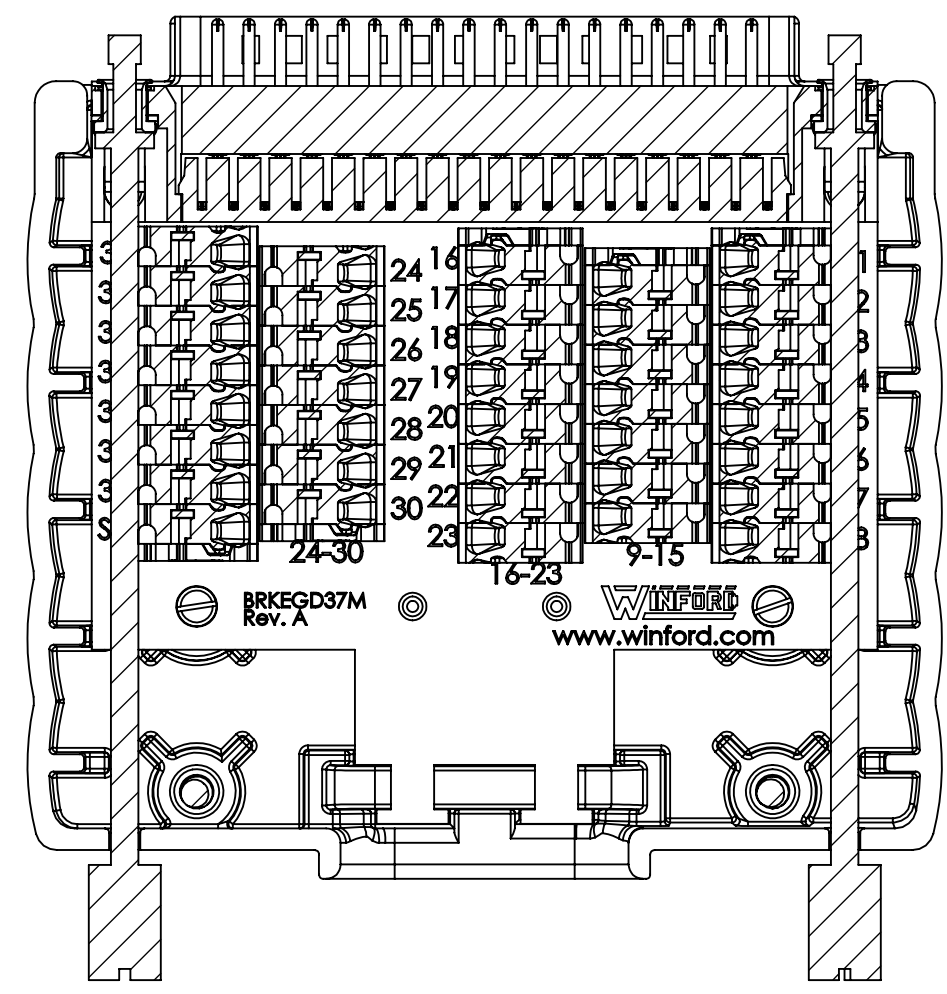
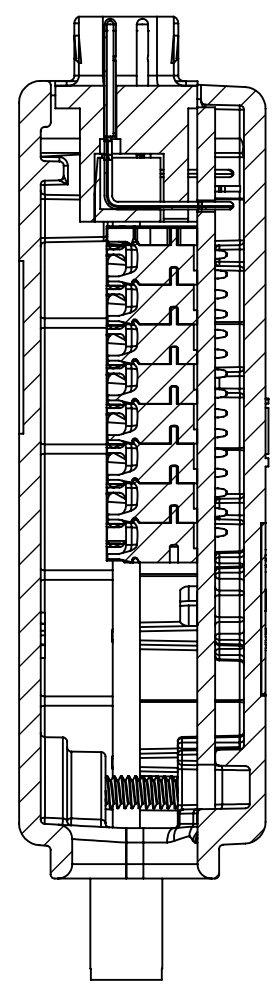
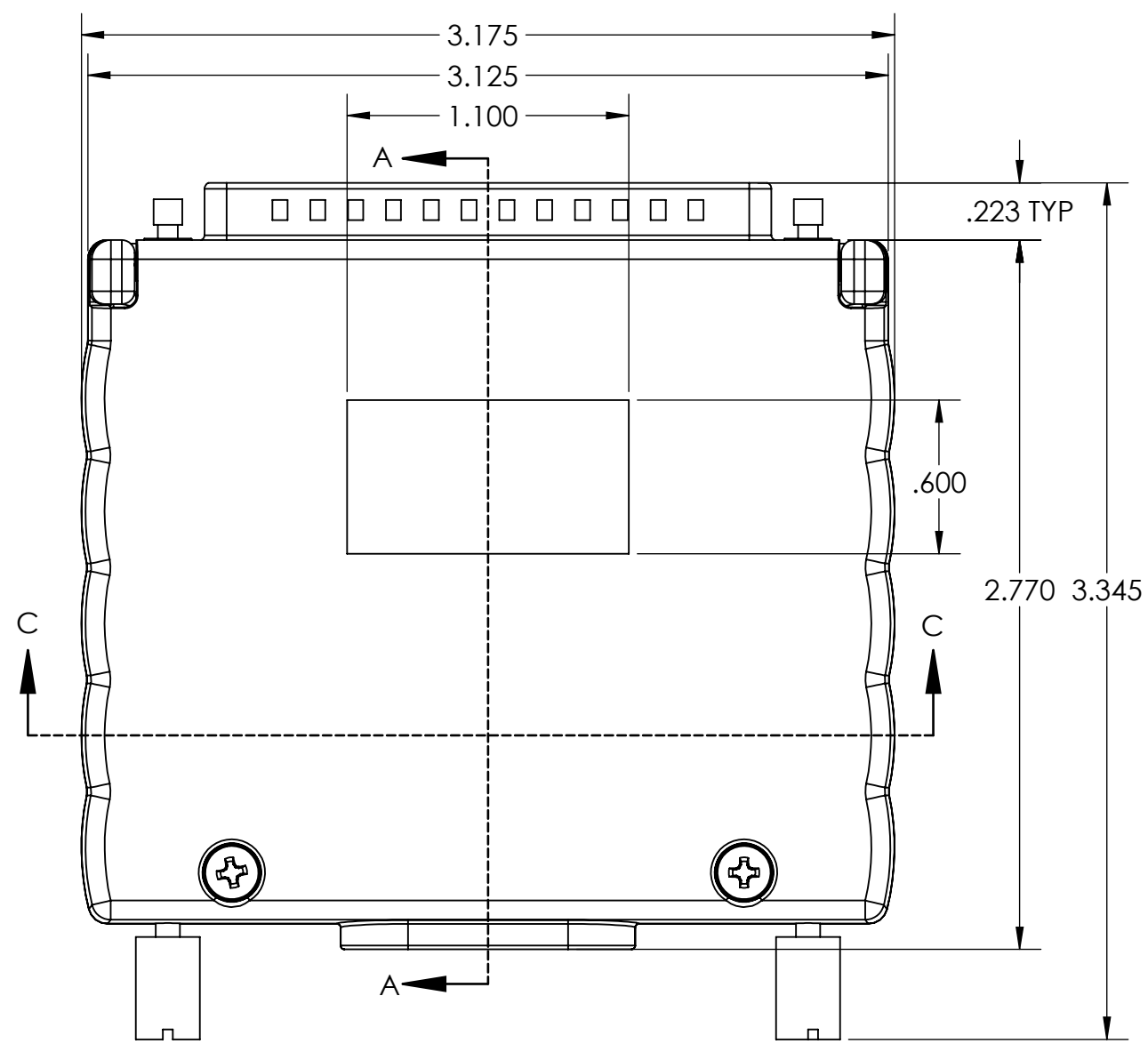

SECTION A-A

SECTION B-B

SECTION C-C

DIM: INCH	DATE: 09/20/2020	RoHS COMPLIANT: YES	DESCRIPTION:
 WINFORD ENGINEERING, LLC 4561 GARFIELD ROAD AUBURN, MI 48611			DB37 Breakout Board W/ Enclosure
www.winford.com		989-671-9721	PART NUMBER (S)
			BRKEGD37M-T
			PART REVISION
			A

4

3

2

1